

# FT59S

AC Tubular Motor | 交流管状电机

Ø59

S: Standard / 标准型  
Mechanic Limit / 机械行程限位

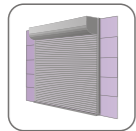

电动金属卷帘门  
Motorized Roller Door



电动遮阳篷  
Motorized Awning

Inner Structure Picture / 电机内部结构示意图



Limit switch 行程  
Capacitor 电容  
Motor 马达  
Brake 刹车  
Gearbox 减速

Dimension Drawing / 电机外形尺寸图

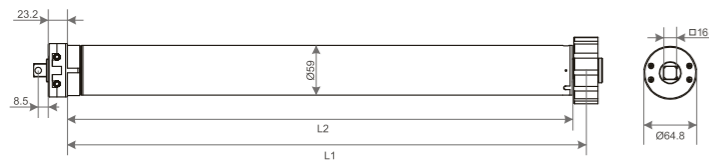

510# LIMIT SWITCH

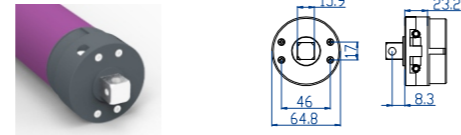

## FT59S Range - Standard Type

Product Certificate 产品认证

Motor Type 型号	Rated Torque 额定扭矩	Rated Speed 输出转速	Tube Diameter 电机外壳直径	Rated Power Input 额定功率	Rated Current 额定电流	Running Time 连续工作时间	Max Number of Turns 最大限位圈数	L1/L2 产品长度
	N.m	rpm	mm	W	A	min	Turn	mm
<b>230V/50Hz - Ip44</b>								
FT59S-60/15	60	15	59	346	1.51	4	24	622/602
FT59S-80/15	80	15	59	380	1.65	4	24	622/602
FT59S-100/9	100	9	59	346	1.51	4	24	622/602
FT59S-100/12	100	12	59	368	1.61	4	24	622/602
FT59S-120/9	120	9	59	365	1.58	4	24	622/602
FT59S-140/7	140	7	59	396	1.71	4	24	622/602
<b>120V/60Hz - Ip44</b>								
FT59S-60/14	60	14	59	338	2.89	4	24	622/602
FT59S-80/14	80	14	59	400	3.37	4	24	622/602
FT59S-100/11	100	11	59	411	3.45	4	24	622/602

AC 230V/50HZ

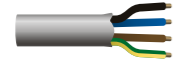

Black=Direction 1 黑色线=火线1  
Blue=Neutral 蓝色线=零线  
Brown=Direction 2 棕色线=火线2  
Green/Yellow=Earth 绿/黄色线=接地线

AC 120V/60HZ



Black=Direction 2 黑色线=火线2  
Red=Direction 1 红色线=火线1  
White=Neutral 白色线=零线  
Green=Earth 绿色线=接地线

# FT59M

AC Tubular Motor | 交流管状电机

Ø59

M: Manual / 手动型  
Mechanic Limit / 机械行程限位

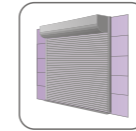

电动金属卷帘门  
Motorized Roller Door

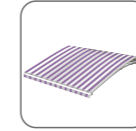

电动遮阳篷  
Motorized Awning

Inner Structure Picture / 电机内部结构示意图

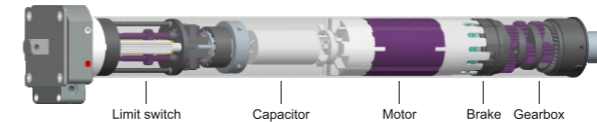

Limit switch 行程  
Capacitor 电容  
Motor 马达  
Brake 刹车  
Gearbox 减速

Dimension Drawing / 电机外形尺寸图

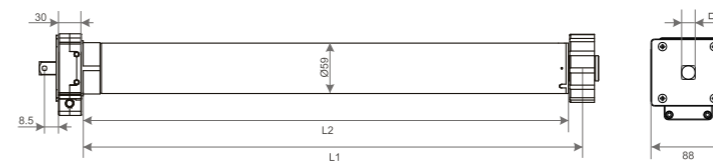

527# LIMIT SWITCH

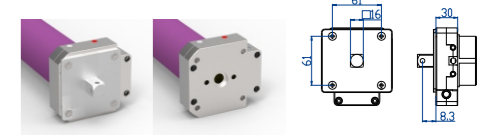

## FT59M Range - Manual Type

Product Certificate 产品认证

Motor Type 型号	Rated Torque 额定扭矩	Rated Speed 输出转速	Tube Diameter 电机外壳直径	Rated Power Input 额定功率	Rated Current 额定电流	Running Time 连续工作时间	Max Number of Turns 最大限位圈数	L1/L2 产品长度
	N.m	rpm	mm	W	A	min	Turn	mm
<b>230V/50Hz - Ip44</b>								
FT59M-60/15	60	15	59	346	1.51	4	24	612/592
FT59M-80/15	80	15	59	380	1.65	4	24	612/592
FT59M-100/9	100	9	59	346	1.51	4	24	612/592
FT59M-100/12	100	12	59	368	1.61	4	24	612/592
FT59M-120/9	120	9	59	365	1.58	4	24	612/592
FT59M-140/7	140	7	59	396	1.71	4	24	612/592
<b>120V/60Hz - Ip44</b>								
FT59M-60/14	60	14	59	338	2.89	4	24	612/592
FT59M-80/14	80	14	59	400	3.37	4	24	612/592
FT59M-100/11	100	11	59	411	3.45	4	24	612/592

AC 230V/50HZ



Black=Direction 1 黑色线=火线1  
Blue=Neutral 蓝色线=零线  
Brown=Direction 2 棕色线=火线2  
Green/Yellow=Earth 绿/黄色线=接地线

AC 120V/60HZ



Black=Direction 2 黑色线=火线2  
Red=Direction 1 红色线=火线1  
White=Neutral 白色线=零线  
Green=Earth 绿色线=接地线

# FT59R

AC Tubular Motor | 交流管状电机

Ø59

R: Radio / 内置接收型  
Mechanic Limit / 机械行程限位



Radio Technology

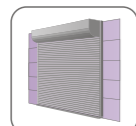

电动金属卷帘门  
Motorized Roller Door

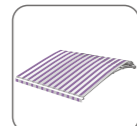

电动遮阳篷  
Motorized Awning

Inner Structure Picture / 电机内部结构示意图



Limit switch 行程  
Capacitor 电容  
Receiver 接收器  
Motor 马达  
Brake 刹车  
Gearbox 减速

Dimension Drawing / 电机外形尺寸图

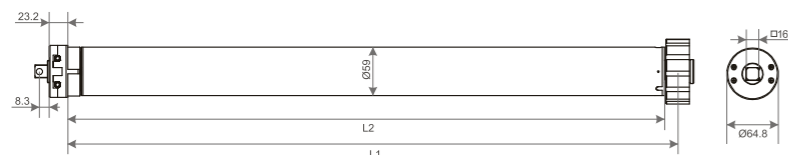

510# LIMIT SWITCH



## FT59R Range - Built-in Receiver Type

Product Certificate 产品认证

Motor Type 型号	Rated Torque 额定扭矩	Rated Speed 输出转速	Tube Diameter 电机外壳直径	Rated Power Input 额定功率	Rated Current 额定电流	Running Time 连续工作时间	Max Number of Turns 最大限位圈数	L1/L2 产品长度
	N.m	rpm	mm	W	A	min	Turn	mm
<b>230V/50Hz - Ip44</b>								
FT59R-60/15	60	15	59	346	1.51	4	24	742/722
FT59R-80/15	80	15	59	380	1.65	4	24	742/722
FT59R-100/9	100	9	59	346	1.51	4	24	742/722
FT59R-100/12	100	12	59	368	1.61	4	24	742/722
FT59R-120/9	120	9	59	365	1.58	4	24	742/722
FT59R-140/7	140	7	59	396	1.71	4	24	742/722
<b>120V/60Hz - Ip44</b>								
FT59R-60/14	60	14	59	338	2.89	4	24	742/722
FT59R-80/14	80	14	59	400	3.37	4	24	742/722
FT59R-100/11	100	11	59	411	3.45	4	24	742/722

AC 230V/50HZ



Blue=Neutral 蓝色线=零线  
Brown=Live 棕色线=火线  
Green/Yellow=Earth 绿/黄色线=接地线

AC 120V/60HZ



Black=Live 黑色线=火线  
White=Neutral 白色线=零线  
Green=Earth 绿色线=接地线

# FT59RM

AC Tubular Motor | 交流管状电机

Ø59

RM: Manual Radio / 手动内置接收型  
Mechanic Limit / 机械行程限位



Radio Technology

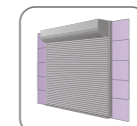

电动金属卷帘门  
Motorized Roller Door

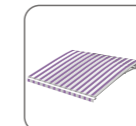

电动遮阳篷  
Motorized Awning

Inner Structure Picture / 电机内部结构示意图



Limit switch 行程  
Capacitor 电容  
Receiver 接收器  
Motor 马达  
Brake 刹车  
Gearbox 减速

Dimension Drawing / 电机外形尺寸图

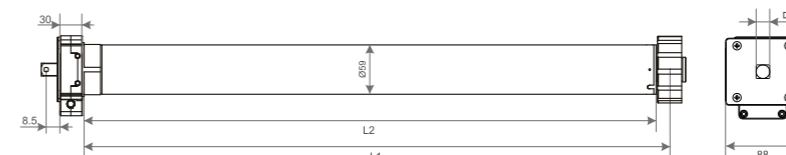

527# LIMIT SWITCH

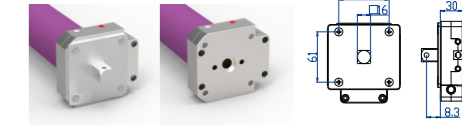

## FT59RM Range - Built-in Receiver, Manual Type

Product Certificate 产品认证

Motor Type 型号	Rated Torque 额定扭矩	Rated Speed 输出转速	Tube Diameter 电机外壳直径	Rated Power Input 额定功率	Rated Current 额定电流	Running Time 连续工作时间	Max Number of Turns 最大限位圈数	L1/L2 产品长度
	N.m	rpm	mm	W	A	min	Turn	mm
<b>230V/50Hz - Ip44</b>								
FT59RM-60/15	60	15	59	346	1.51	4	24	762/742
FT59RM-80/15	80	15	59	380	1.65	4	24	762/742
FT59RM-100/9	100	9	59	346	1.51	4	24	762/742
FT59RM-100/12	100	12	59	368	1.61	4	24	762/742
FT59RM-120/9	120	9	59	365	1.58	4	24	762/742
FT59RM-140/7	140	7	59	396	1.71	4	24	762/742
<b>120V/60Hz - Ip44</b>								
FT59RM-60/14	60	14	59	338	2.89	4	24	762/742
FT59RM-80/14	80	14	59	400	3.37	4	24	762/742
FT59RM-100/11	100	11	59	411	3.45	4	24	762/742

AC 230V/50HZ



Blue=Neutral 蓝色线=零线  
Brown=Live 棕色线=火线  
Green/Yellow=Earth 绿/黄色线=接地线

AC 120V/60HZ



Black=Live 黑色线=火线  
White=Neutral 白色线=零线  
Green=Earth 绿色线=接地线

# FT59E

AC Tubular Motor | 交流管状电机

AC Tubular Motor | 交流管状电机

Ø59

E: Electronic Radio / 电子内置接收型

Electronic Limit + Built-in Wireless Receiver + The Third Limit + Jogging & Tilt Function  
电子行程限位 + 内置无线接收器 + 第三行程点 + 点动调光功能

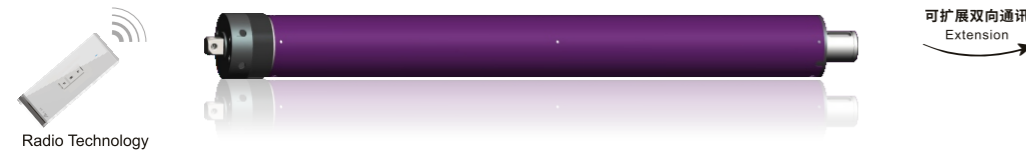

**NEW**

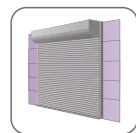

电动金属卷帘门  
Motorized Roller Door

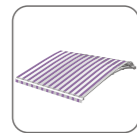

电动遮阳篷  
Motorized Awning

Inner Structure Picture / 电机内部结构示意图



Electronic Limit + Receiver 电子行程限位+接收器  
Capacitor 电容  
Motor 马达  
Brake 刹车  
Gearbox 减速

Dimension Drawing / 电机外形尺寸图

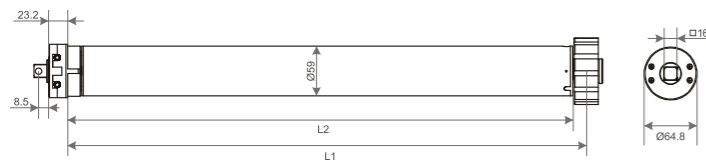

552# LIMIT SWITCH



## FT59E Range - Electronic Radio Type

Product Certificate 产品认证

Motor Type 型号	Rated Torque 额定扭矩	Rated Speed 输出转速	Tube Diameter 电机外壳直径	Rated Power Input 额定功率	Rated Current 额定电流	Running Time 连续工作时间	Max Number of Turns 最大限位圈数	L1/L2 产品长度
	N.m	rpm	mm	W	A	min	Turn	mm
								CCC TÜV CE RoHS
<b>230V/50Hz - Ip44</b>								
FT59E-60/15	60	15	59	346	1.51	4	∞	625/605
FT59E-80/15	80	15	59	380	1.65	4	∞	625/605
FT59E-100/9	100	9	59	346	1.51	4	∞	625/605
FT59E-100/12	100	12	59	368	1.61	4	∞	625/605
FT59E-120/9	120	9	59	365	1.58	4	∞	625/605
<b>120V/60Hz - Ip44</b>								
FT59E-60/14	60	14	59	338	2.89	4	∞	625/605
FT59E-80/14	80	14	59	400	3.37	4	∞	625/605
FT59E-100/11	100	11	59	411	3.45	4	∞	625/605

AC 230V/50HZ



Blue=Neutral 蓝色线=零线  
Brown=Live 棕色线=火线  
Green/Yellow=Earth 绿/黄色线=接地线

AC 120V/60HZ



Black=Live 黑色线=火线  
White=Neutral 白色线=零线  
Green=Earth 绿色线=接地线

# Various electronic radio tubular motors for option

多种电子内置接收型马达可供选择



FT59EIA

Electronic Limit + Built-in Wireless Receiver + The Third Limit + Jogging & Tilt Function + Connect Single Key Rebound Mechanic Switch / 电子行程限位 + 内置无线接收器 + 第三行程点 + 点动调光功能 + 外接单键可反弹机械开关功能



RE07-1  
单通道发射器  
Single Channel Wireless Emitter

**NEW**



单键可反弹开关  
Single Key Rebound  
Mechanic Switch



电源  
Power

# FT92S

AC Tubular Motor | 交流管状电机

Ø92

S: Standard / 标准型  
Mechanic Limit / 机械行程限位

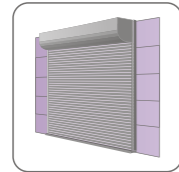
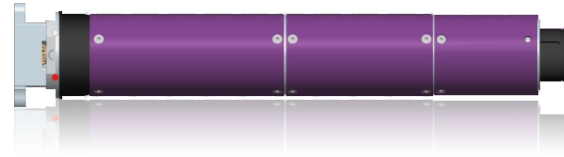

电动金属卷帘门  
Motorized Roller Door

Inner Structure Picture / 电机内部结构示意图

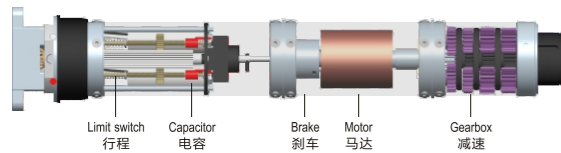

Limit switch 行程  
Capacitor 电容  
Brake 刹车  
Motor 马达  
Gearbox 减速

Dimension Drawing / 电机外形尺寸图

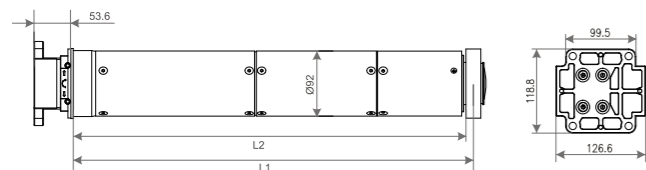

920# LIMIT SWITCH

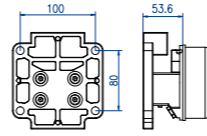
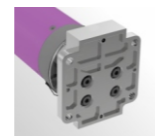

## FT92S Range - Standard Type

Product Certificate 产品认证

Motor Type 型号	Rated Torque 额定扭矩	Rated Speed 输出转速	Tube Diameter 电机外壳直径	Rated Power Input 额定功率	Rated Current 额定电流	Running Time 连续工作时间	Max Number of Turns 最大限位圈数	L1/L2 产品长度
	N.m	rpm	mm	W	A	min	Turn	mm
								CCC TÜV CE RoHS
<b>230V/50Hz - Ip44</b>								
FT92S-230/12	230	12	92	1027	4.75	4	22	490/478
FT92S-300/9	300	9	92	1027	4.75	4	22	526/514
<b>120V/60Hz - Ip44</b>								
FT92S-230/14	230	14	92	881	8.17	4	22	532/520
FT92S-300/11	300	11	92	881	8.17	4	22	568/556

AC 230V/50HZ



Black=Direction 1 黑色线=火线1  
Blue=Neutral 蓝色线=零线  
Brown=Direction 2 棕色线=火线2  
Green/Yellow=Earth 绿/黄色线=接地线

AC 120V/60HZ



Black=Direction 2 黑色线=火线2  
Red=Direction 1 红色线=火线1  
White=Neutral 白色线=零线  
Green=Earth 绿色线=接地线

# FT92M

AC Tubular Motor | 交流管状电机

Ø92

M: Manual / 手动型  
Mechanic Limit / 机械行程限位

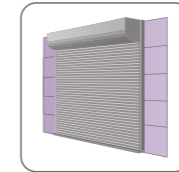
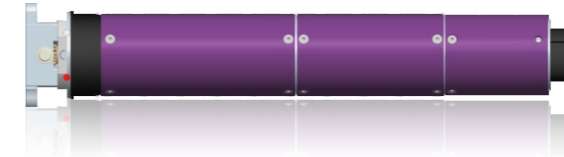

电动金属卷帘门  
Motorized Roller Door

Inner Structure Picture / 电机内部结构示意图

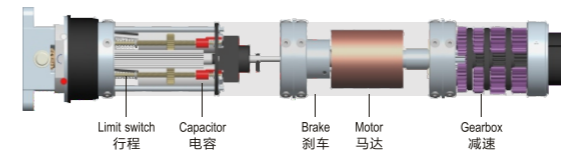

Limit switch 行程  
Capacitor 电容  
Brake 刹车  
Motor 马达  
Gearbox 减速

Dimension Drawing / 电机外形尺寸图

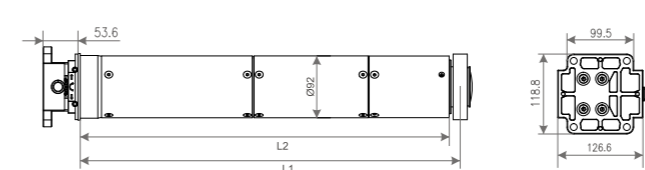

927# LIMIT SWITCH

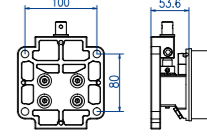
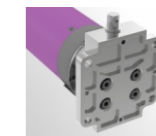

## FT92M Range - Manual Type

Product Certificate 产品认证

Motor Type 型号	Rated Torque 额定扭矩	Rated Speed 输出转速	Tube Diameter 电机外壳直径	Rated Power Input 额定功率	Rated Current 额定电流	Running Time 连续工作时间	Max Number of Turns 最大限位圈数	L1/L2 产品长度
	N.m	rpm	mm	W	A	min	Turn	mm
								CCC TÜV CE RoHS
<b>230V/50Hz - Ip44</b>								
FT92M-230/12	230	12	92	1027	4.75	4	22	490/478
FT92M-300/9	300	9	92	1027	4.75	4	22	526/514
<b>120V/60Hz - Ip44</b>								
FT92M-230/14	230	14	92	881	8.17	4	22	532/520
FT92M-300/11	300	11	92	881	8.17	4	22	568/556

AC 230V/50HZ



Black=Direction 1 黑色线=火线1  
Blue=Neutral 蓝色线=零线  
Brown=Direction 2 棕色线=火线2  
Green/Yellow=Earth 绿/黄色线=接地线

AC 120V/60HZ



Black=Direction 2 黑色线=火线2  
Red=Direction 1 红色线=火线1  
White=Neutral 白色线=零线  
Green=Earth 绿色线=接地线

# FD25AE

DC Tubular Motor | 直流管状电机

Ø25

## AE: Built-In Adapter Electronic Radio / 内置适配器电子接收型

DC Motor + Electronic Limit + Integrated Radio Control + Built-in Adapter + The Third Limit + Jogging & Tilt Function + Resistance Protection Function

直流电机 + 电子行程限位 + 内置接收功能 + 内置适配器 + 第三行程点 + 点动调光功能 + 遇阻保护功能

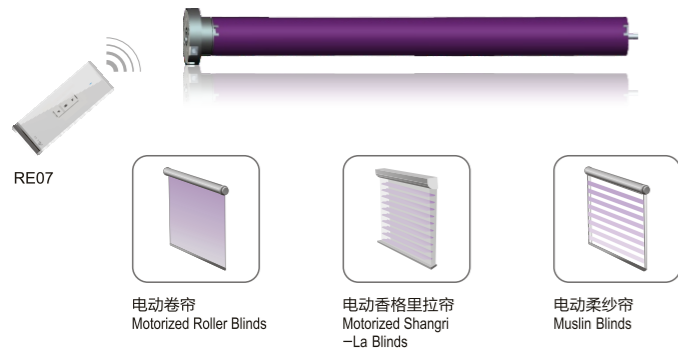

可扩展双向通讯  
Extension



### Inner Structure Picture / 电机内部结构示意图

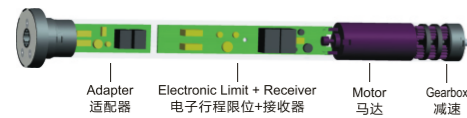

### Dimension Drawing / 电机外形尺寸图

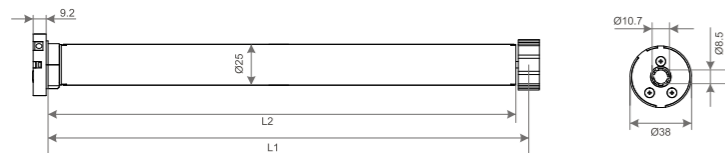

252# LIMIT SWITCH

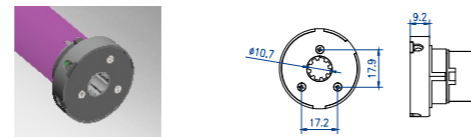

## FD25AE Range - Built-In Adapter Electronic Radio Type

Product Certificate 产品认证

Motor Type 型号	Rated Torque 额定扭矩	Rated Speed 输出转速	Tube Diameter 电机外壳直径	Rated Voltage 额定功率	Rated Current 额定电流	Running Time 连续工作时间	Max Number of Turns 最大限位圈数	L1/L2 产品长度
	N.m	rpm	mm	W	A	min	Turn	mm
<b>CE RoHS</b>								
✦ 100-240V/50Hz(60Hz) - Ip44								
FD25AE-0.7/28	0.7	28	25	7.6	0.059	5	∞	473/463
FD25AE-1.1/30	1.1	30	25	11.4	0.13	5	∞	473/463
FD25AE-1.5/32	1.5	32	25	13	0.13	5	∞	473/463
FD25AE-2/35	2	35	25	18	0.15	5	∞	473/463

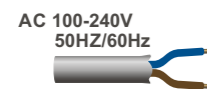

# FD25E

DC Tubular Motor | 直流管状电机

Ø25

## E: DC Electronic Radio / 电子内置接收型

DC Motor + Electronic Limit + Integrated Radio Control + External Adapter + The Third Limit + Jogging & Tilt Function + Resistance Protection Function

直流电机 + 电子行程限位 + 内置接收功能 + 外置适配器 + 第三行程点 + 点动调光功能 + 遇阻保护功能

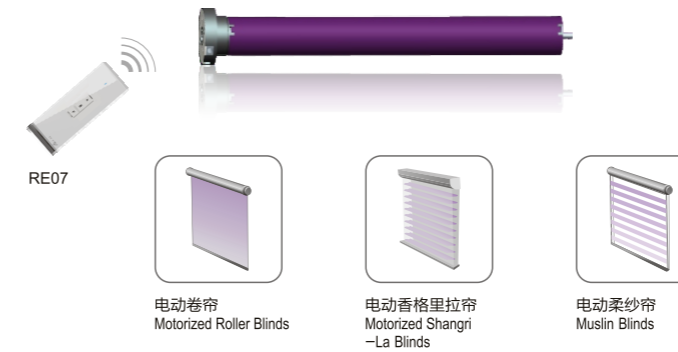

可扩展双向通讯  
Extension



### Inner Structure Picture / 电机内部结构示意图

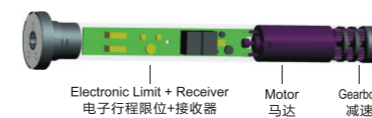

### Dimension Drawing / 电机外形尺寸图

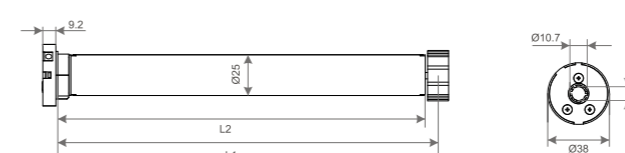

251# LIMIT SWITCH



## FD25E Range - Electronic Radio Type

Product Certificate 产品认证

Motor Type 型号	Rated Torque 额定扭矩	Rated Speed 输出转速	Tube Diameter 电机外壳直径	Rated Power Input 额定功率	Rated Current 额定电流	Running Time 连续工作时间	Max Number of Turns 最大限位圈数	L1/L2 产品长度
	N.m	rpm	mm	W	A	min	Turn	mm
<b>CE RoHS</b>								
✦ 12V - Ip44								
FD25E-0.7/28	0.7	28	25	7.6	0.55	5	∞	313/303
FD25E-1.1/30	1.1	30	25	8.75	0.68	5	∞	313/303
FD25E-1.5/32	1.5	32	25	12.3	0.9	5	∞	313/303
FD25E-2/35	2	35	25	14.8	1.2	5	∞	313/303



AG52

Switch Power Supply Adaptor / 开关电源适配器  
Input / 输入: 100-240V AC 0.5A 50/60Hz  
Output / 输出: 12.6V/1.0A  
Using with FD25E Motor/For 0.7N.m Motor  
与FD25E型电机配合使用时,适用于0.7N.m电机



AG71

Switch Power Supply Adaptor / 开关电源适配器  
Input / 输入: 100-240V AC 0.5A 50/60Hz  
Output / 输出: 12.0V/1.5A  
For 1.1N.m - 2N.m Motor / 适用于1.1N.m - 2N.m电机

# FD25CE

DC Tubular Motor | 直流管状电机

Ø25

**CE: DC Lower Power Consumption Electronic Radio / 低功耗电子内置接收型**

DC Motor + Electronic Limit + Integrated Radio Control + Low-Power Consumption + The Third Limit + Jogging & Tilt Function + Resistance Protection Function

直流电机 + 电子行程限位 + 内置接收功能 + 低功耗 + 第三行程点 + 点动调光功能 + 遇阻保护功能

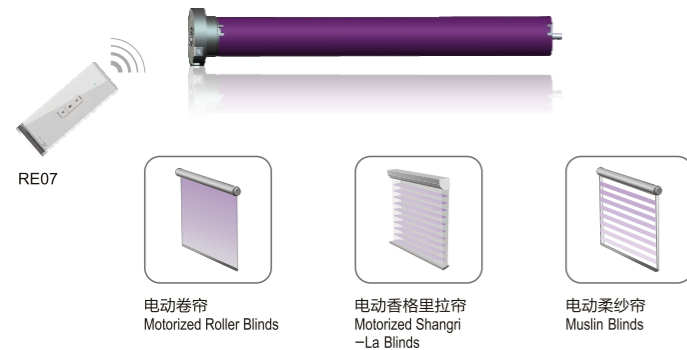

Apply To: Battery Pole, Adaptor, Solar Rechargeable Board  
适用于: 电池棒、开关电源适配器、太阳能板

**方案1: 适配器供电**  
Plan1: Adaptor Power Supply  
**AG52/AG71**  
开关电源适配器  
Switch Power Supply Adaptor  
适配器根据实际扭矩来选择型号  
The Adaptor Selects The Model According To The Actual Torque

**方案2: 电池棒供电**  
Plan2: Battery Pole Power Supply  
**AG62**  
可充电锂电池棒  
Rechargeable Lithium Battery Pole

**方案3: 电池棒+太阳能板供电**  
Plan3: Battery Pole Plus Solar Rechargeable Board Power Supply  
**AG62**  
可充电锂电池棒  
Rechargeable Lithium Battery Pole  
**AG82**  
5V 太阳能充电板  
5V Solar Rechargeable Board

Inner Structure Picture / 电机内部结构示意图



Dimension Drawing / 电机外形尺寸图

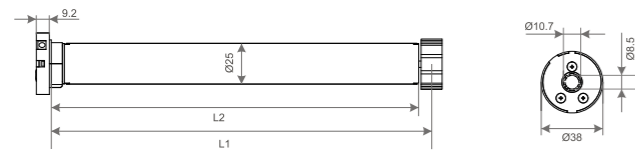

251# LIMIT SWITCH

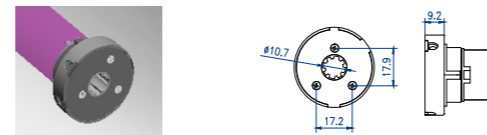

## FD25CE Range - Lower Power Consumption Electronic Radio Type Product Certificate 产品认证

Motor Type 型号	Rated Torque 额定扭矩	Rated Speed 输出转速	Tube Diameter 电机外壳直径	Rated Power Input 额定功率	Rated Current 额定电流	Running Time 连续工作时间	Max Number of Turns 最大限位圈数	L1/L2 产品长度
	N.m	rpm	mm	W	A	min	Turn	mm
<b>12V - Ip44</b>								
FD25CE-0.7/28	0.7	28	25	5.8	0.48	5	∞	313/303
FD25CE-1.1/30	1.1	30	25	7.4	0.63	5	∞	313/303
FD25CE-1.5/32	1.5	32	25	11.2	0.9	5	∞	313/303
FD25CE-2/35	2	35	25	14.4	1.2	5	∞	313/303

**AG52**

Switch Power Supply Adaptor / 开关电源适配器  
Input / 输入: 100-240V AC 0.5A 50/60Hz  
Output / 输出: 12.6V/1.0A  
Using With FD25CE Motor, For 0.7N.m Motor  
与FD25CE型电机配合使用时, 适用于0.7N.m电机

**AG71**

Switch Power Supply Adaptor / 开关电源适配器  
Input / 输入: 100-240V AC 0.5A 50/60Hz  
Output / 输出: 12.0V/1.5A  
For 1.1N.m And 1.5N.m Motor  
适用于1.1N.m和1.5N.m电机

**AG62**

Rechargeable Lithium Battery Pole / 可充电锂电池棒  
Charging Voltage / 充电电压: 5V/2A  
Output Voltage / 输出电压: 12V  
Charging Interface / 充电接口: Micro USB  
Comes With a USB Type-A To Micro USB Cable  
附赠一条USB Type-A转Micro USB数据线

**AG82**

5V Solar Rechargeable Board/5V太阳能充电板

# FD25BE

DC Tubular Motor | 直流管状电机

Ø25

**BE: Built-in Battery Electronic Radio / 内置锂电池电子接收型**

DC Motor + Electronic Limit + Integrated Radio Control + Built-in Lithium Battery + Low-Power Consumption + The Third Limit + Jogging & Tilt Function + Resistance Protection Function

直流电机 + 电子行程限位 + 内置接收功能 + 内置锂电池 + 低功耗 + 第三行程点 + 点动调光功能 + 遇阻保护功能

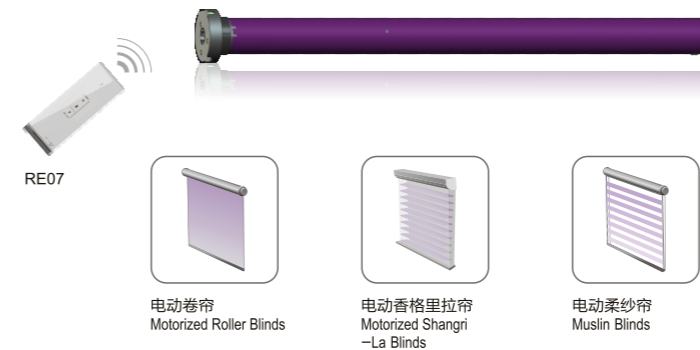

Apply To: Solar Panel, Adaptor  
适用于: 太阳能板、开关电源适配器

**方案1: 适配器充电**  
Plan1: Adaptor Charging  
**AG52**  
开关电源适配器  
Switch Power Supply Adaptor

**方案2: 太阳能板充电**  
Plan2: Solar Rechargeable Board Charging  
**AG61**  
12V 太阳能充电板  
12V Solar Rechargeable Board  
晴天2天可充满  
Can be fully charged in two days on sunny day

Inner Structure Picture / 电机内部结构示意图

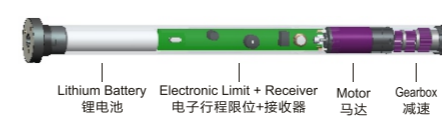

Dimension Drawing / 电机外形尺寸图

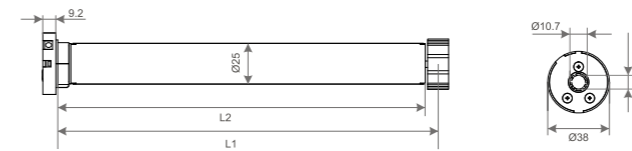

253# LIMIT SWITCH

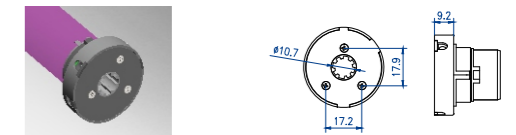

## FD25BE Range - Built-in Battery Electronic Radio Type Product Certificate 产品认证

Motor Type 型号	Rated Torque 额定扭矩	Rated Speed 输出转速	Tube Diameter 电机外壳直径	Rated Power Input 额定功率	Rated Current 额定电流	Running Time 连续工作时间	Max Number of Turns 最大限位圈数	L1/L2 产品长度
	N.m	rpm	mm	W	A	min	Turn	mm
<b>12V - Ip44</b>								
FD25BE-0.7/28	0.7	28	25	5.2	0.42	5	∞	553/543
FD25BE-1.1/30	1.1	30	25	7.2	0.61	5	∞	553/543
FD25BE-1.5/32	1.5	32	25	11.2	0.9	5	∞	553/543
FD25BE-2/35	2	35	25	14.4	1.2	5	∞	553/543

**AG52**

Switch Power Supply Adaptor / 开关电源适配器  
Input / 输入: 100-240V AC 0.5A 50/60Hz  
Output / 输出: 12.6V/1.0A  
Using With FD25BE Motor, For 0.7N.m - 2N.m Motor  
与FD25BE型电机配合使用时, 适用于0.7N.m - 2N.m电机

**AG61**

12V Solar Rechargeable Board/12V太阳能充电板  
晴天2天可充满  
Can be fully charged in two days on sunny day

# FD35CE

DC Tubular Motor | 直流管状电机

Ø35

**CE: DC Lower Power Consumption Electronic Radio / 低功耗电子内置接收型**  
DC Motor + Electronic Limit + Integrated Radio Control + Low-Power Consumption + The Third Limit + Jogging & Tilt Function

直流电机 + 电子行程限位 + 内置接收功能 + 低功耗 + 第三行程点 + 点动调光功能



NEW

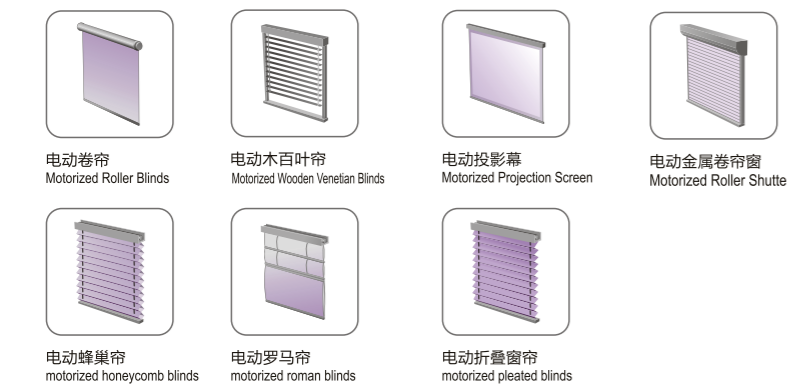

Apply To: Adaptor  
适用于: 开关电源适配器



Inner Structure Picture / 电机内部结构示意图

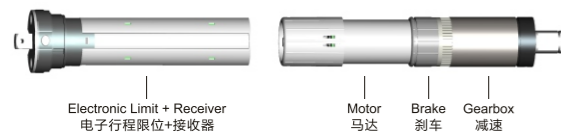

Dimension Drawing / 电机外形尺寸图

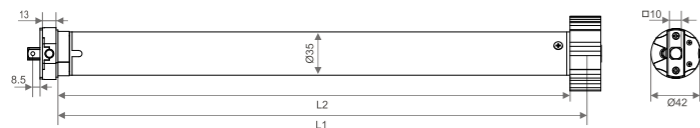

325 # LIMIT SWITCH



## FD35CE Range - Lower Power Consumption Electronic Radio Type

Motor Type 型号	Rated Torque 额定扭矩	Rated Speed 输出转速	Tube Diameter 电机外壳直径	Rated Power Input 额定功率	Rated Current 额定电流	Running Time 连续工作时间	Max Number of Turns 最大限位圈数	L1/L2 产品长度
	N.m	rpm	mm	W	A	min	Turn	mm
12V - Ip44								CE RoHS
FD35CE -10/9	10	9	35	24	2.2	5	∞	414/401

AG80

Switch Power Supply Adaptor / 开关电源适配器  
Input / 输入: 100-240V AC 1.5A 50/60Hz  
Output / 输出: 12.0V --- 3.0A 36.0W

# FD35BE

DC Tubular Motor | 直流管状电机

Ø35

**BE: Built-in Battery Electronic Radio / 内置锂电池电子接收型**  
DC Motor + Electronic Limit + Integrated Radio Control + Built-in Lithium Battery + Low-Power Consumption + The Third Limit + Jogging & Tilt Function

直流电机 + 电子行程限位 + 内置接收功能 + 内置锂电池 + 低功耗 + 第三行程点 + 点动调光功能



NEW

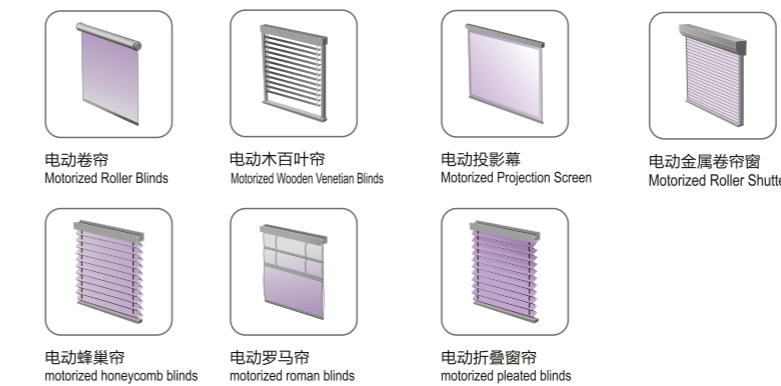

Apply To: Solar Panel, Adaptor  
适用于: 太阳能板、开关电源适配器



Inner Structure Picture / 电机内部结构示意图

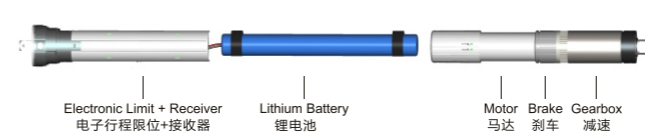

Dimension Drawing / 电机外形尺寸图

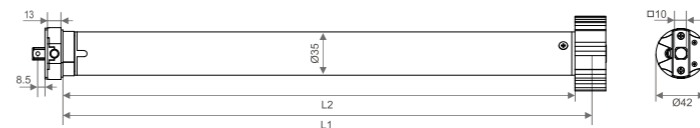

325 # LIMIT SWITCH



## FD35BE Range - Built-in Battery Electronic Radio Type

Motor Type 型号	Rated Torque 额定扭矩	Rated Speed 输出转速	Tube Diameter 电机外壳直径	Rated Power Input 额定功率	Rated Current 额定电流	Running Time 连续工作时间	Max Number of Turns 最大限位圈数	L1/L2 产品长度
	N.m	rpm	mm	W	A	min	Turn	mm
12V - Ip44								CE RoHS
FD35BE -10/9	10	9	35	24	2.2	5	∞	614/601

AG52

Switch Power Supply Adaptor / 开关电源适配器  
Input / 输入: 100-240V AC 0.5A 50/60Hz  
Output / 输出: 12.6V/1.0A

AG61

12V Solar Rechargeable Board/12V太阳能充电板  
晴天2天可充满  
Can be fully charged in two days on sunny day

# Curtain Motor

## 开合帘电机

开合帘电机适用于直线及弧形布艺开合窗帘,广泛应用于家装,酒店,别墅等场所.

通过与发射器配合使用,可控制一层或多层布料,安装方便,操作简单.铝轨道更有直轨或是弯轨可供选择.是家居自动化必不可少的重要成员之一.

Curtain motor can be used to straight or arc-shaped curtain, widely used to home decoration, hotel, and villa. Through work with remote, it can control one or multi level fabric, easy installation, convenient operation. Aluminum track has the options for straight or arc-shaped. It plays an important role in the field of home automation.

菲尔格开合帘电机在设计上采用超静音设计,体验前所未有的宁静.

功能上采用软启动及软停止设计,窗帘运行更加流畅.

智能电子行程设计,无需调试设定.

手拉启动功能,操作方式更加人性化确保每次都是非凡的用户体验.

In design, Feierge curtain motor adopt super-silence design, experience unprecedented peace.  
In function, soft start and soft stop design let curtain run more smoothly.  
intelligent electronic limit has the function of automatic memory no need to set limitation by manual.  
Pull start function, operation way more humanized, ensure every time is extraordinary experience.



从超静音设计到缓启动缓停止设计,  
再到电子记忆限位,遇阻停止手拉启动功能,  
菲尔格确保每次都是非凡的用户体验.

From super silence design to soft start soft stop,  
to electronic memory limit function, resistance stop and  
pull start function.  
FEIERGE ensure every time is extraordinary experience.



# Motorized Curtain

## 电动窗帘功能说明 Function Description

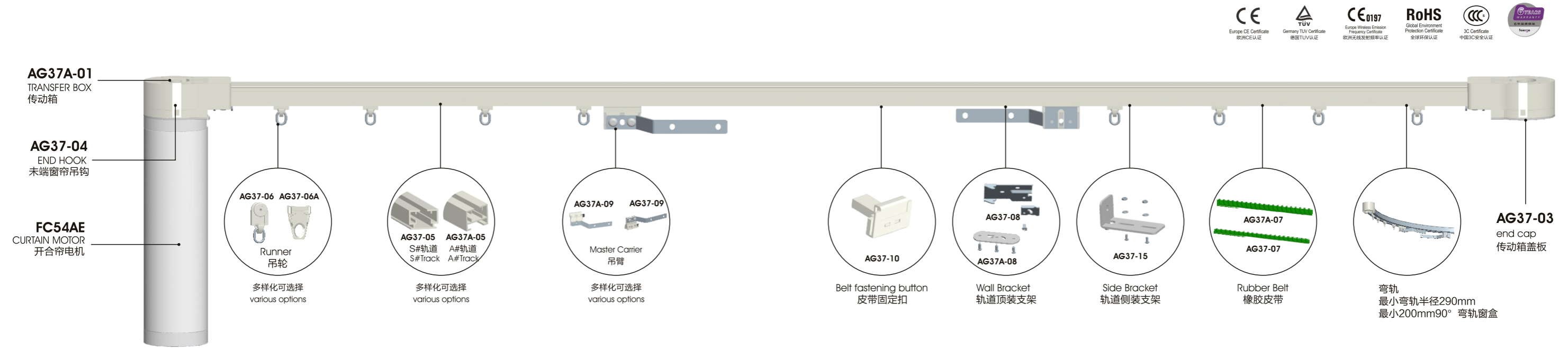

### 优雅运行功能 / Elegant Operation Function

DC 开合帘自带轻开轻合功能,当它运行至近行程点时,可实行减速运行,开合帘运行更加优雅。  
DC curtain motor with light open and light close function. When it starts and nears the limit position, the speed will obviously slow and make the curtain running more elegantly.

### 电子记忆行程功能 / Electronic Memory Limit Function

带电子记忆行程,不需要手动设行程,大大缩减了设置时间.电子行程功能可以自动校准行程,使行程定位更加精准。  
This motor with electronic limit, no need to set the limit position by hand, it greatly shortens the debugging time. The electronic limit function can automatically delete the limit difference of each day and keep the precise limit position for a long time.

### 内置接收功能 / Built-in Receiver Function

FEIERGE 开合帘带内置接收功能,可以跟任何一款菲尔格发射器配合使用.开合帘可以实现单独控制或者群控。  
FEIERGE curtain motor is endowed with built-in receiver function, which is compatible with any other type of FEIERGE emitters. Curtains can be controlled separately or in a group system.

### 遇阻停止功能 / Resistance And Stop Function

当窗帘遇到障碍,就会自动停止运转。  
the curtain will automatically stop if meet resistance.

### 轻触启动功能 / Light Touch-Start Function

手拉窗帘20cm可自动启动电机,开合帘会自动运行直到完全打开或完全关闭为止.(可以不使用发射器)  
If use hand to pull the curtain lightly around 20CM, the curtain will run automatically and stop until fully opened or fully closed (no need use remote).

### 寿命长,经久耐用 / Long Lifetime, Durable In Use

菲尔格开合帘电机使用同步驱动皮带,功能上防老化,防腐蚀.寿命可以达到15,000次以上.如果按照一天两次来计算,可以用20年之久。  
use high strength synchronous belt with anti-aging and acid-resistance function. This system can keep its shape after 15,000 times' use. It has 20 years' life span if calculated by 2 time per day.

### 断电手动功能 / Power off Manual Function

断电时,像拉手动帘子一样,我们可以轻松控制帘子的开与关。  
When the power is off, just do as we do to a common manual operated curtain, we can lightly pull the curtain to open and close.

### 外置干触点开关功能 / External dry contact switch function

通过干触点,可以接机械开关或轻触开关。  
Through the dry contact, can connect the mechanical switch or light-touch switch.

# FC54AE



## AE: Built-in Adapter Electronic Radio/内置适配器电子遥控型

Electronic limit+Built-in receiver+Resistance and stop function+Light touch-start function+Power off -manual function+Long lifetime function+External connecting with dry contact function+The Third, Fourth, Fifth limit position+Elegant operation function+RS485 Communication function  
 电子记忆限位功能+内置遥控功能+遇阻停止功能+轻触启动功能+停电手拉功能+超长寿命功能+外接干触点功能+第三、四、五限位行程功能+优雅运行功能+RS485通讯协议

50kg

AC 100-240V/50Hz.60Hz

可扩展双向通讯  
Extension

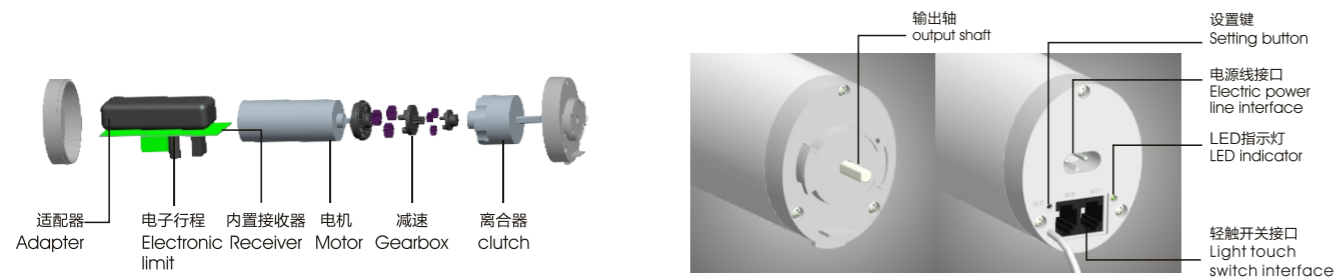

## FC54AE Range - Built-in Adapter Electronic Radio

Product Certificate 产品认证



Motor Type 型号	Safety Curtain Weight 安全载重	Rated Torque 额定扭矩	Rated Speed 输出转速	Open/Close Speed 打开/关闭速度	Rated Current 额定电流	Running Time 连续工作时间	Protection Degree 防护等级	Max Number of Turns 最大限位圈数	Track Length 轨道长度	Weight 产品重量
	Kg	N.m	rpm	cm/s	A	h	Ip	Turn	m	Kg
★ 100-240V/50Hz.60Hz										
FC54AE-1.2/75	50	1.2	75	12	0.13	240	40	∞	≤12	1.04

AC 100-240V/50Hz.60Hz

Brown=Direction 棕色线=火线  
Blue=Neutral 蓝色线=零线



Power wire  
电源线  
AG37-16

# Function Specification 功能说明

## 负载 / Load

安全窗帘的重量 Safety Curtain Weight

开合帘电机 FC54AE-1.2/75  
Curtain Motor FC54AE-1.2/75

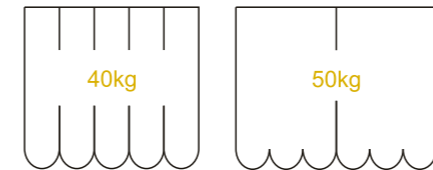

One-way draw 单开帘电机 Two-way draw 双开帘电机

## 轨道安装的距离 Dimensions Of Track Installation

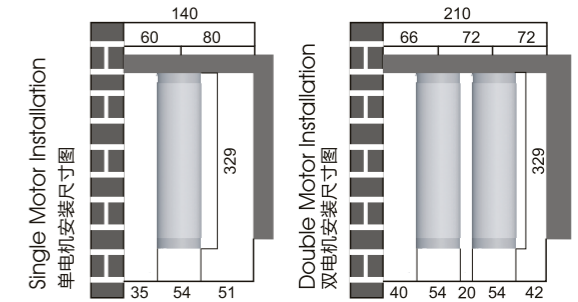

## CONTROL SYSTEM 控制系统

### 无线遥控+干触点单控 wireless+dry contact single control

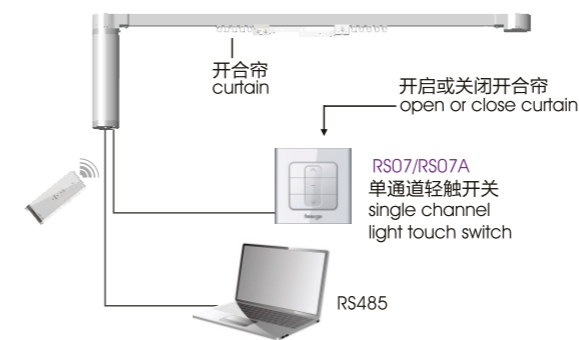

### 单层控制 Single control

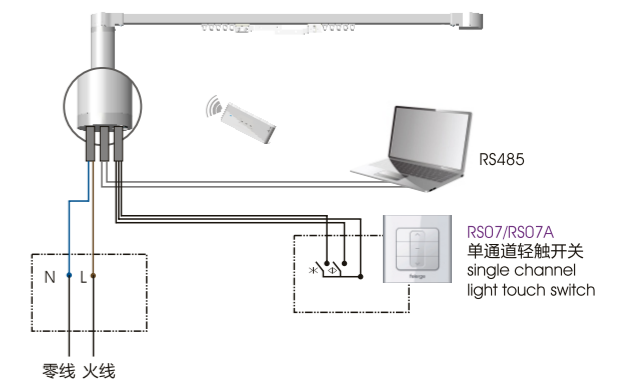

### 无线遥控+干触点双控 wireless+dry contact double control

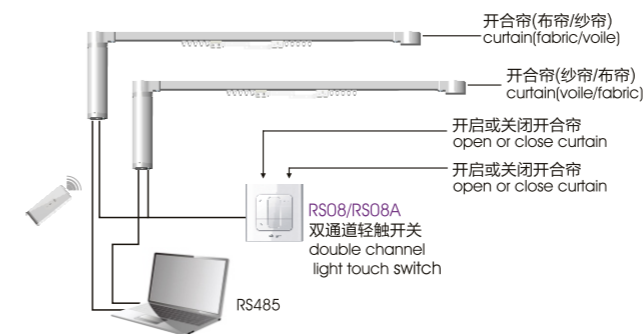

### 双层控制 Double control

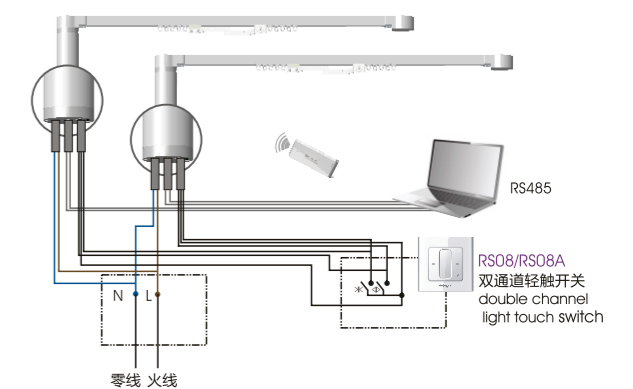

# Curtain Track

电动窗帘功能说明 System

## A# TRACK 轨道

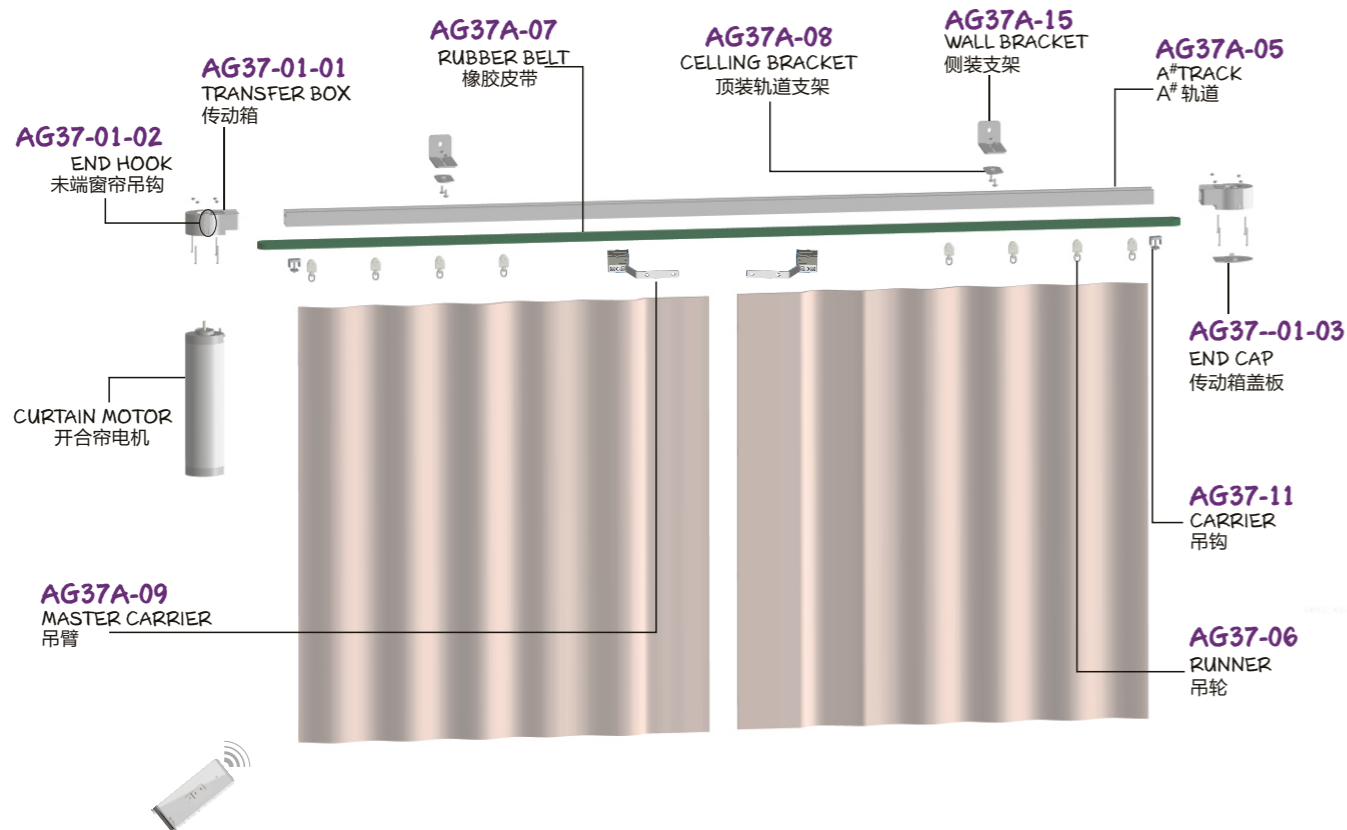

A# 轨道嫁接外观  
The engrafting overview of A# track

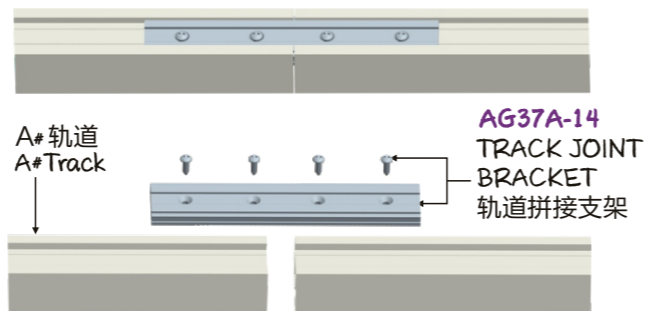

### Motorized 电动窗帘 Curtain Motor Track 轨道系统特点

- 使用方便，运行平稳
- 安全舒适，牢固耐用

# A# Track and Accessories A#轨道及配件

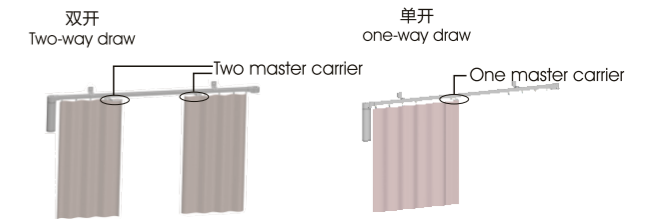
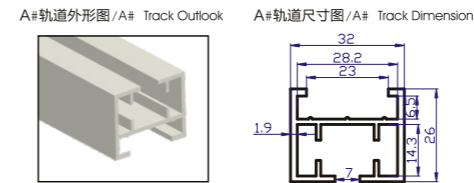

序号 NO	产品图片 PRODUCT PHOTO	产品名称 PRODUCT NAME	产品型号 PRODUCT CODE	描述 DESCRIPTION	所需数量 REQUIRED QUANTITY
1		A # TRACK A # 轨道	AG37A-05	ALUMINIUM 铝合金	BUY ACCORDING TO THE REQUESTED LENGTH (UNIT: METRE) 按所需长度购买 (单位: 米)
2		RUBBER BELT 橡胶皮带	AG37A-07	GREEN MAX. 100KG 绿色最大量100KG	BUY ACCORDING TO THE REQUESTED LENGTH (UNIT: METRE) PIS ACCORDING TO INSTRUCTION GUIDER TO CALCULATE THE LENGTH 按所需长度购买 (单位: 米) 提示: 具体算法看说明书
3		MASTER CARRIER 吊臂	AG37A-09		TWO-WAY DRAW: 2PCS/SET ONE-WAY DRAW: 1PCS/SET 单开: 1套 1个 双开: 1套 2个
4		CELLING BRACKET 顶装轨道支架	AG37A-08	METAL 金属	TWO PCS FOR ONE METER TRACK, ONE MORE METER TRACK ONE MORE BRACKET 1米轨道2个, 每增加1米轨道加1个
		WALL BRACKET 侧装支架	AG37-15	SINGLE TRACK 单轨	
5		RUNNER 吊轮	AG37A-06	STANDARD RUNNER 标准吊轮	6 PCS FOR EVERY 1 METRE 每米轨道6个
			AG37-06A		
6		TRACK JOINT GROUP 嫁接轨道组合	AG37A-14	FOR CONNECT TOW TRACKS 用于两根轨道拼接	1PCS FOR EVERY JOINT 1个轨道连接段1个
7		TRANSFER BOX ASSEMBLY 传动箱组合 FC54AE	AG37A-01		ONE WAY DRAW 单开 AG37A-01-01 2PCS AG37-01-03 1PCS AG37-01-02 2PCS AG37-11 2PCS
		CARRIER 吊钩	AG37-11		two WAY DRAW 双开 AG37A-01-01 2PCS AG37-01-03 1PCS AG37-01-02 2PCS AG37-11 2PCS

# Curtain Track

电动窗帘功能说明 System

## S# TRACK 轨道

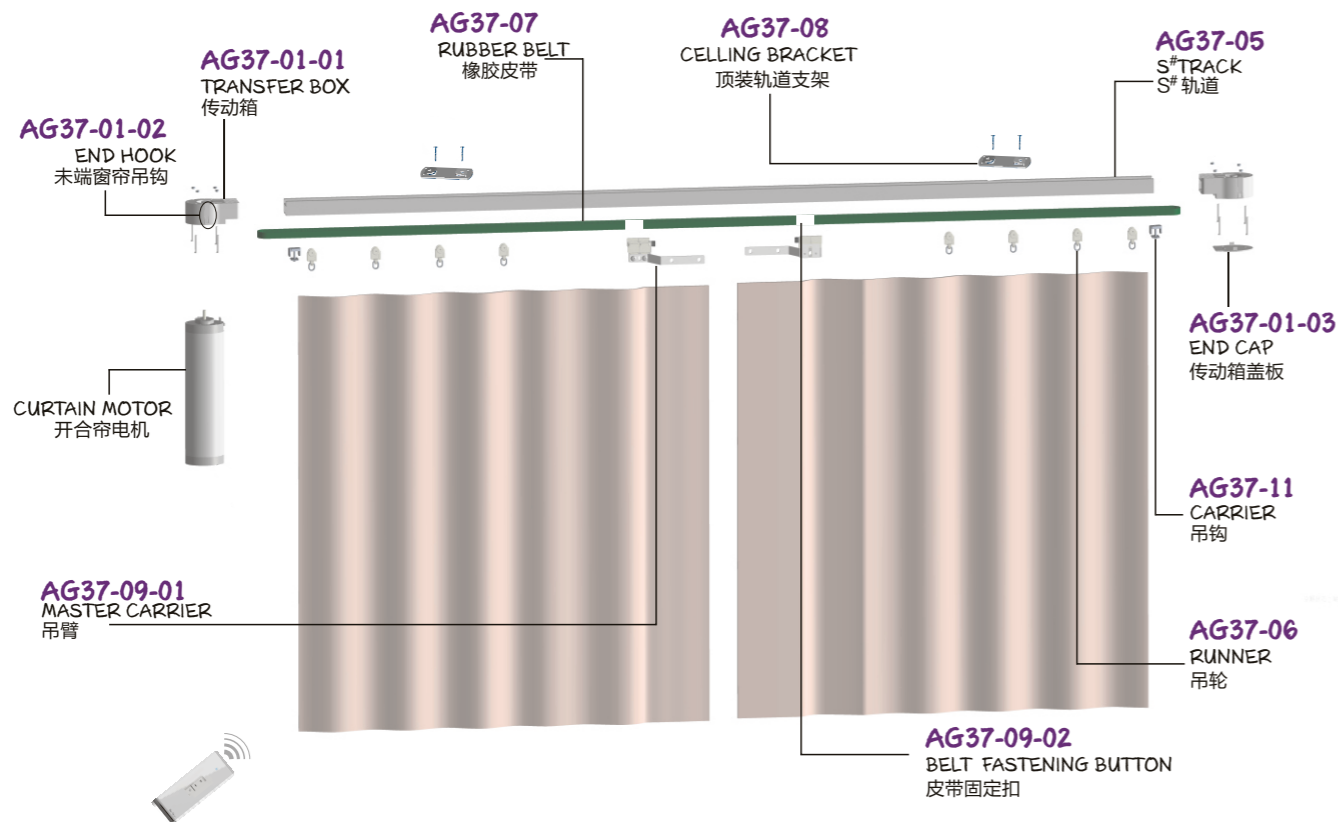

S# 轨道 S# Track

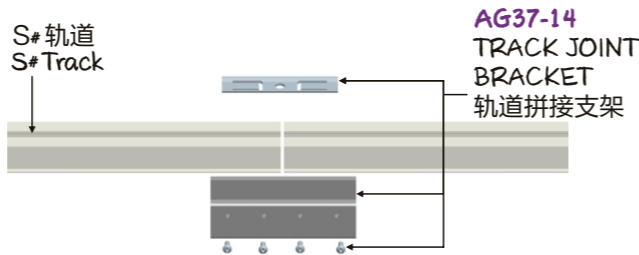

### Motorized 电动窗帘 Curtain Motor Track 轨道系统特点

- 使用方便，运行平稳
- 安全舒适，牢固耐用

# S# Track and Accessories s#轨道及配件

S# 轨道外形图 / S# Track Outlook S# 轨道尺寸图 / S# Track Dimension

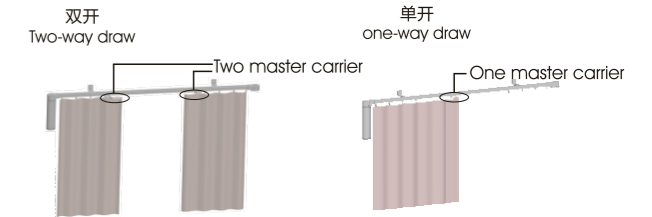
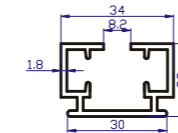
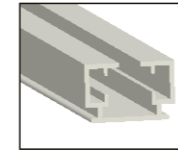

序号 NO	产品图片 PRODUCT PHOTO	产品名称 PRODUCT NAME	产品型号 PRODUCT CODE	描述 DESCRIPTION	所需数量 REQUIRED QUANTITY
1		S# TRACK S# 轨道	AG37-05	ALUMINIUM 铝合金	BUY ACCORDING TO THE REQUESTED LENGTH (UNIT: METRE) 按所需长度购买 (单位: 米)
2		RUBBER BELT 橡胶皮带	AG37-07	GREEN MAX. 100KG 绿色最大量100KG	BUY ACCORDING TO THE REQUESTED LENGTH (UNIT: METRE) 按所需长度购买 (单位: 米) PIS ACCORDING TO INSTRUCTION GUIDER TO CALCULATE THE LENGTH 提示: 具体算法看说明书
3		MASTER CARRIER 吊臂	AG37-09-01		ONE WAY DRAW 单开 AG37-09-01 1PCS AG37-01-02 2PCS
		RUBBER BELT FASTENING BUTTON ASSEMBLY 皮带固定扣组合	AG37-09-02		TWO WAY DRAW 双开 AG37-09-01 2PCS AG37-09-02 4PCS
4		CELLING BRACKET 顶装轨道支架	AG37-08	METAL 金属	TWO PCS FOR ONE METER TRACK, ONE MORE METER TRACK ONE MORE BRACKET 1米轨道2个, 每增加1米轨道加1个
		WALL BRACKET 侧装支架	AG37-15	SINGLE TRACK 单轨	
5		RUNNER 吊轮	AG37-06	STANDARD RUNNER 标准吊轮	6 PCS FOR EVERY 1 METRE 每米轨道6个
			AG37-06A		
6		TRACK JOINT GROUP 嫁接轨道组合	AG37-14	FOR CONNECT TOW TRACKS 用于两根轨道拼接	1PCS FOR EVERY JOINT 1个轨道连接段1个
7		TRANSFER BOX ASSEMBLY 传动箱组合 FC54AE	AG37-01		ONE WAY DRAW 单开 AG37-01-01 2PCS AG37-01-03 1PCS AG37-01-02 2PCS AG37-11 2PCS
		CARRIER 吊钩	AG37-11		TWO WAY DRAW 双开 AG37-01-01 2PCS AG37-01-03 1PCS AG37-01-02 2PCS AG37-11 2PCS